

Letter

P

Pack

The Star of the Show

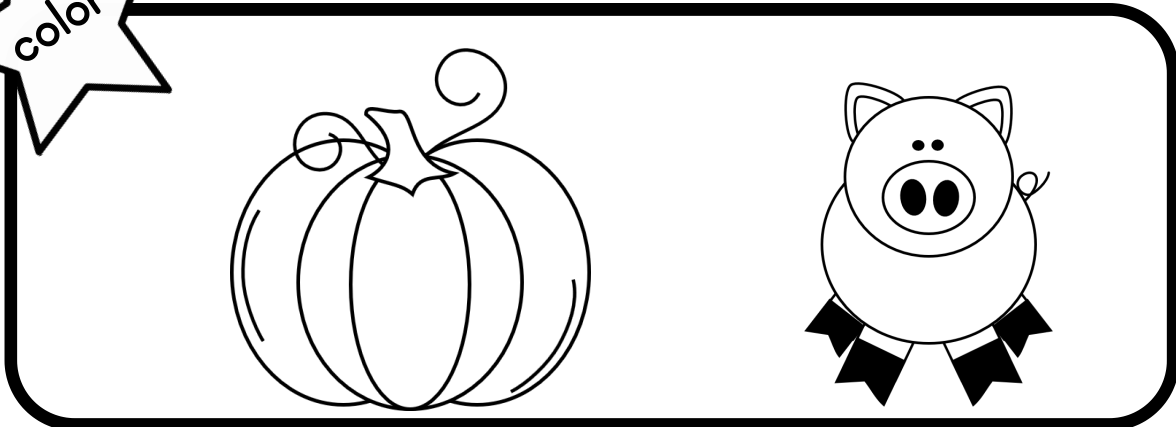
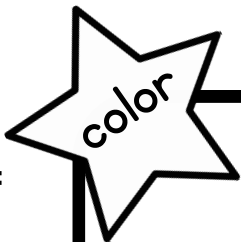
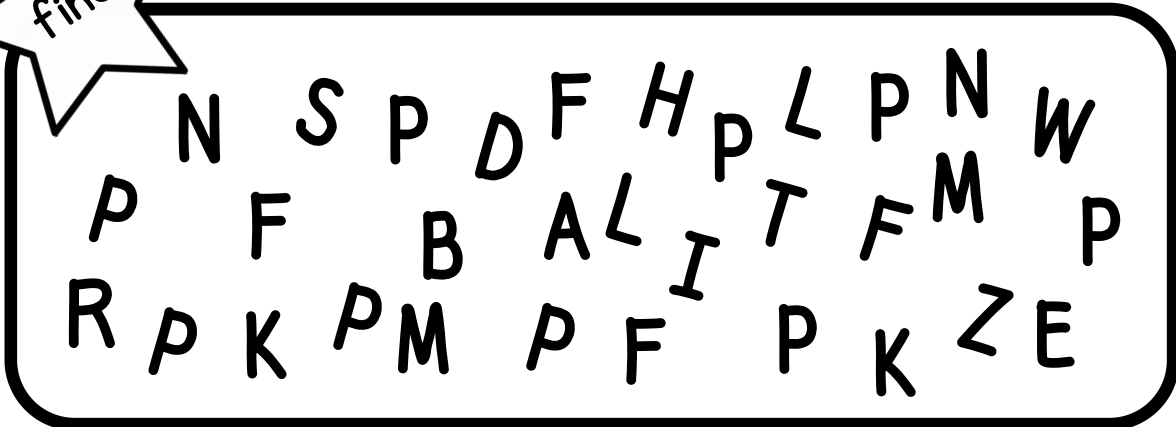
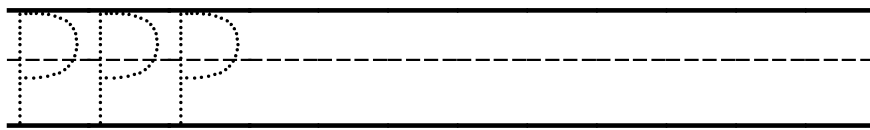
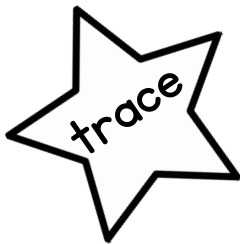
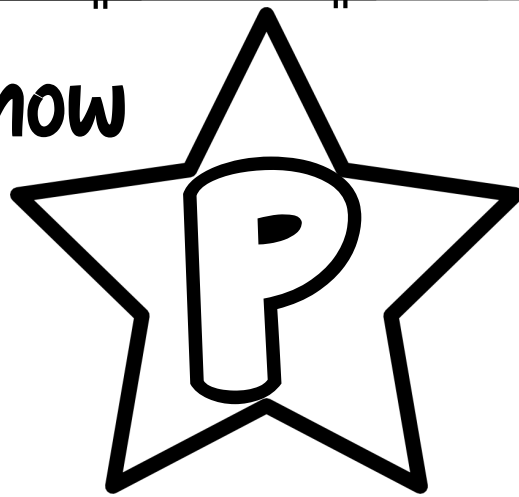

Trace the letter "P"

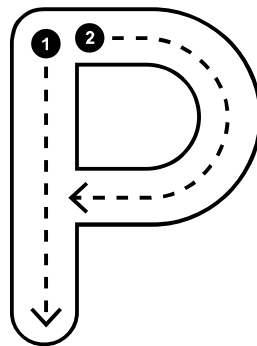
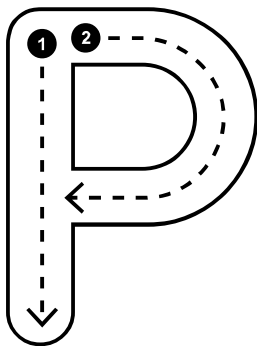
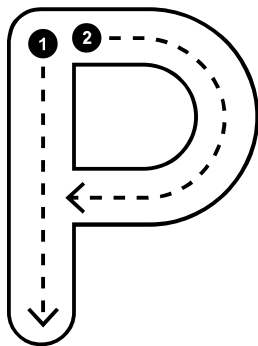

Color the shapes with the letter "P"

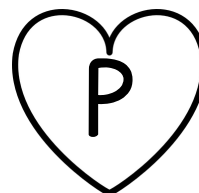
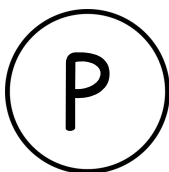
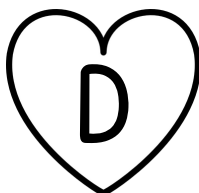
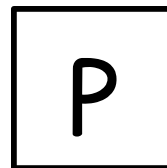
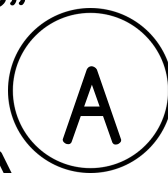
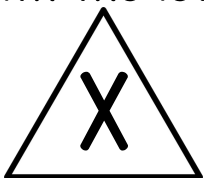
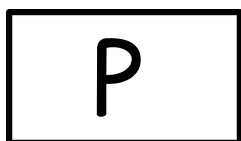

Color the pictures that start with "P"

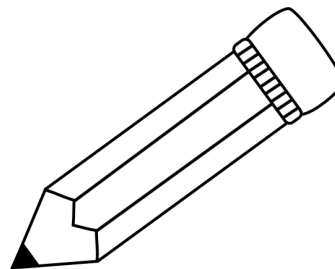
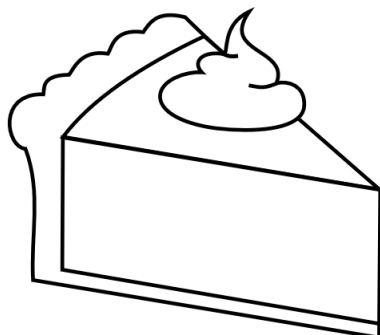
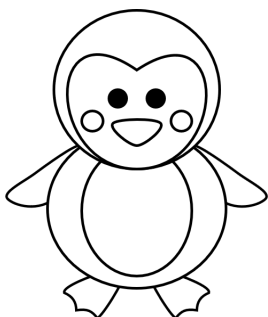

Cut out the pictures at the bottom. Glue to the boxes if they start with the letter "P".

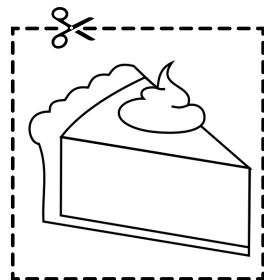
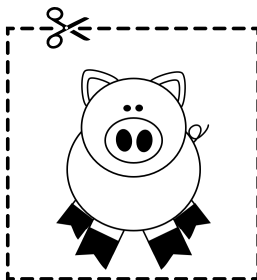
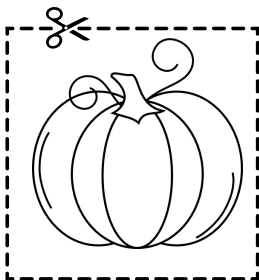
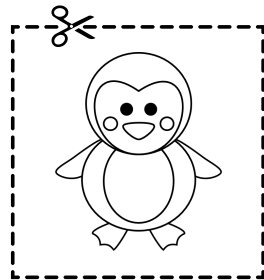
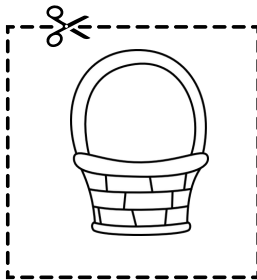
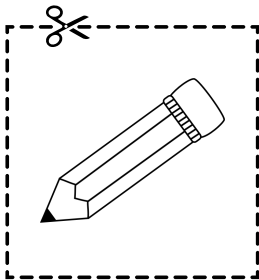
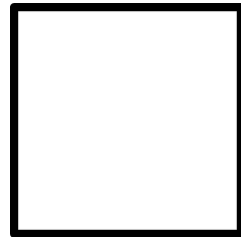
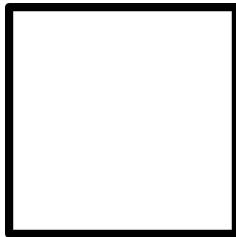
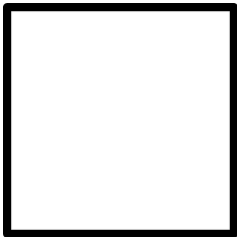
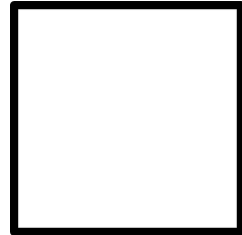
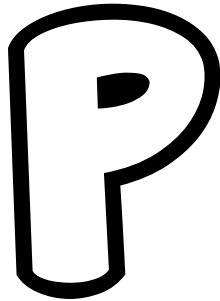
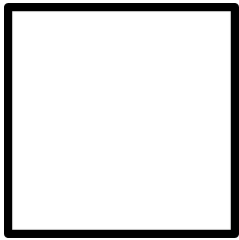



p i z z a P

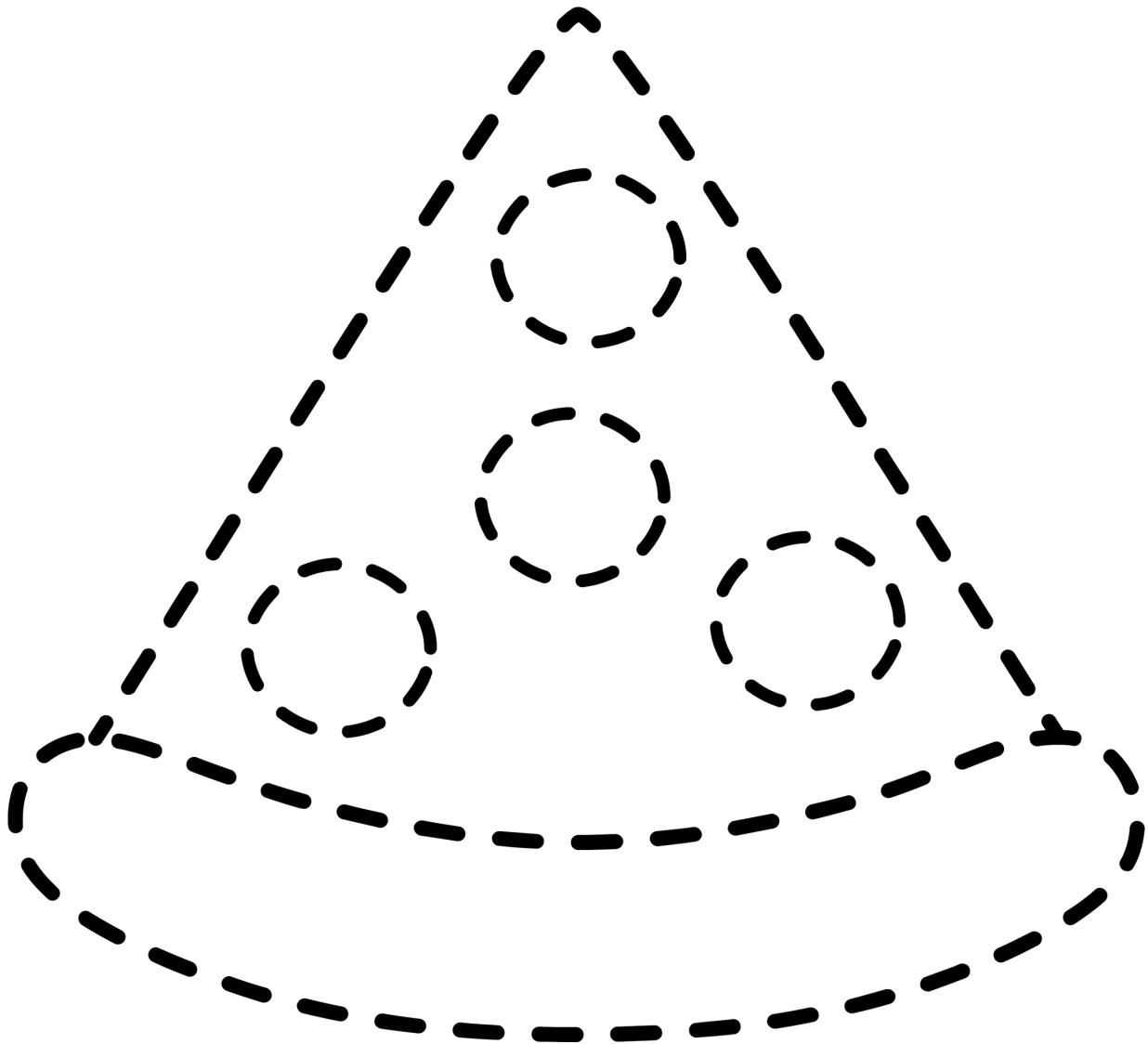

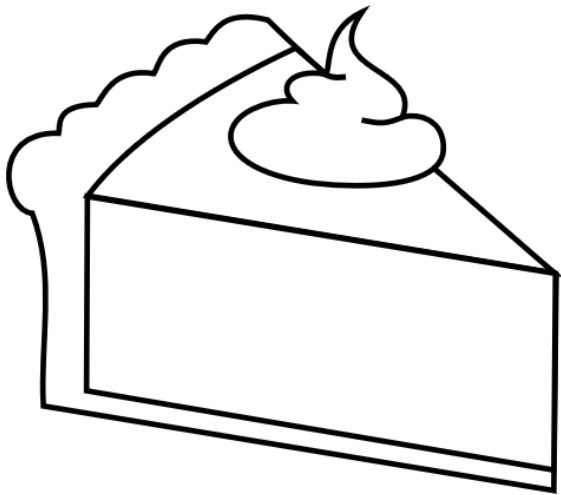

_____ie

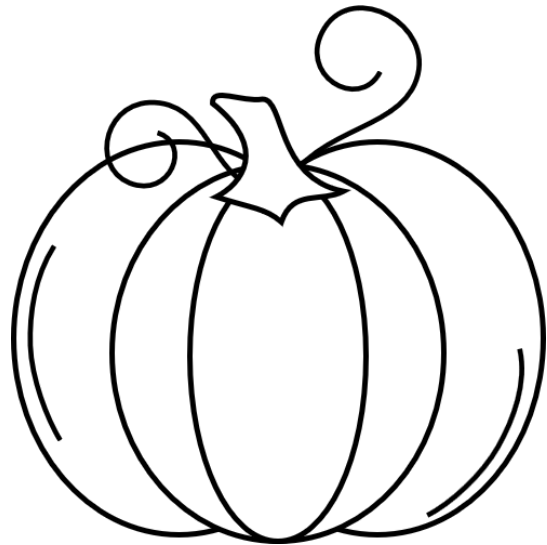

_____umpkin

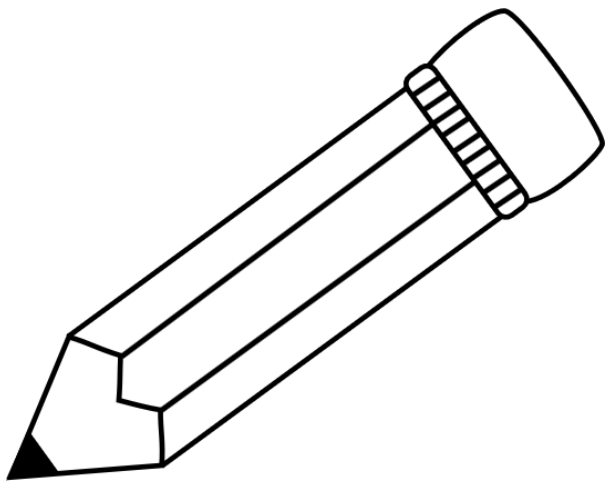

_____encil

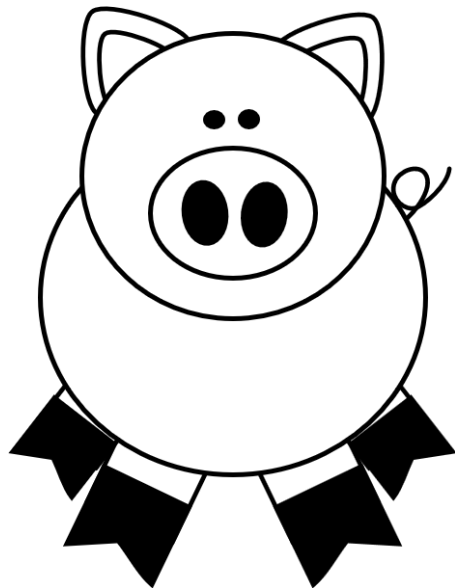

_____ig

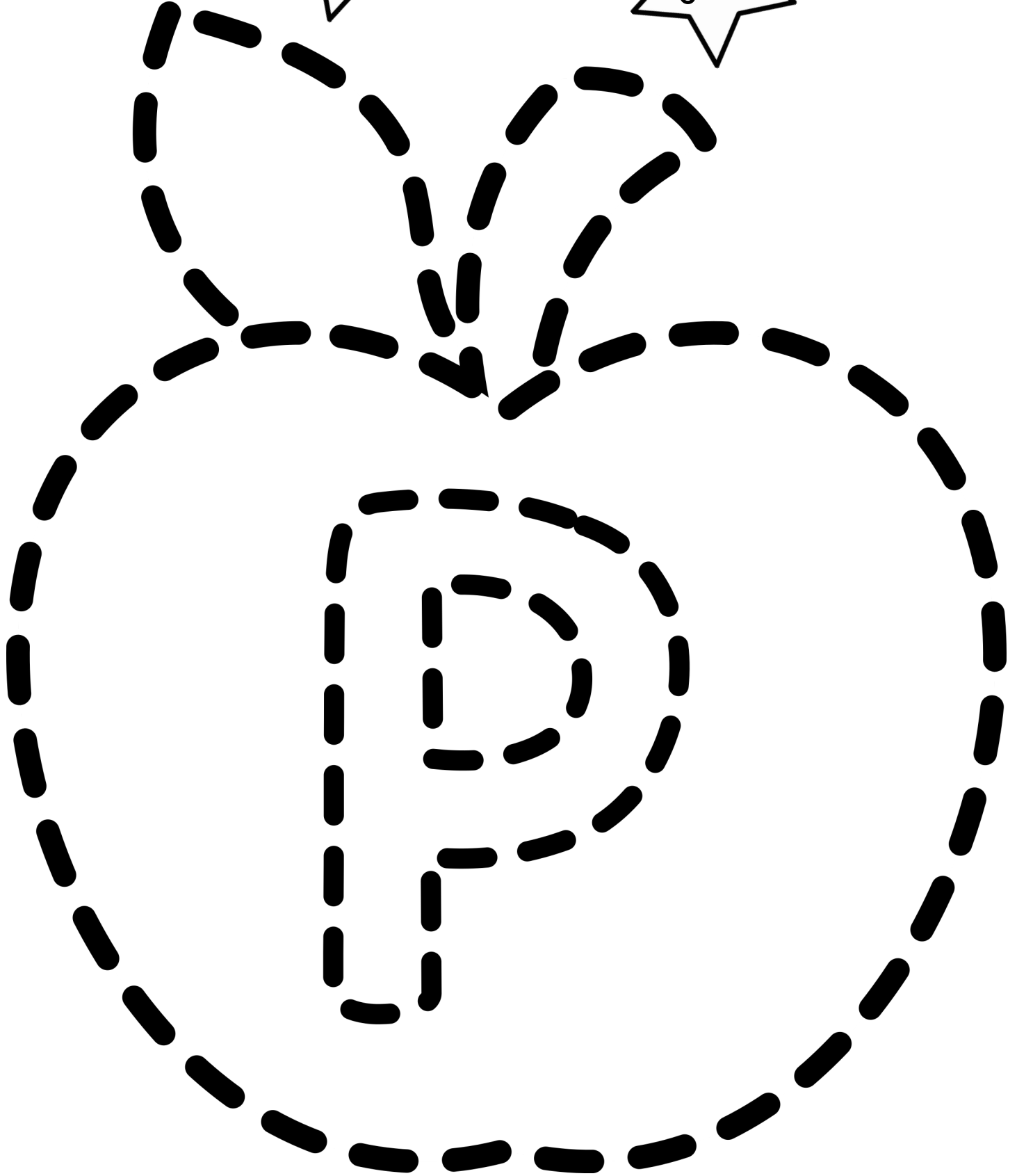
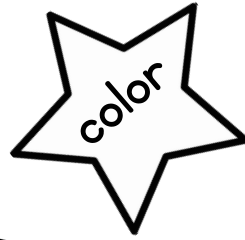

Decorate your tee-shirt.

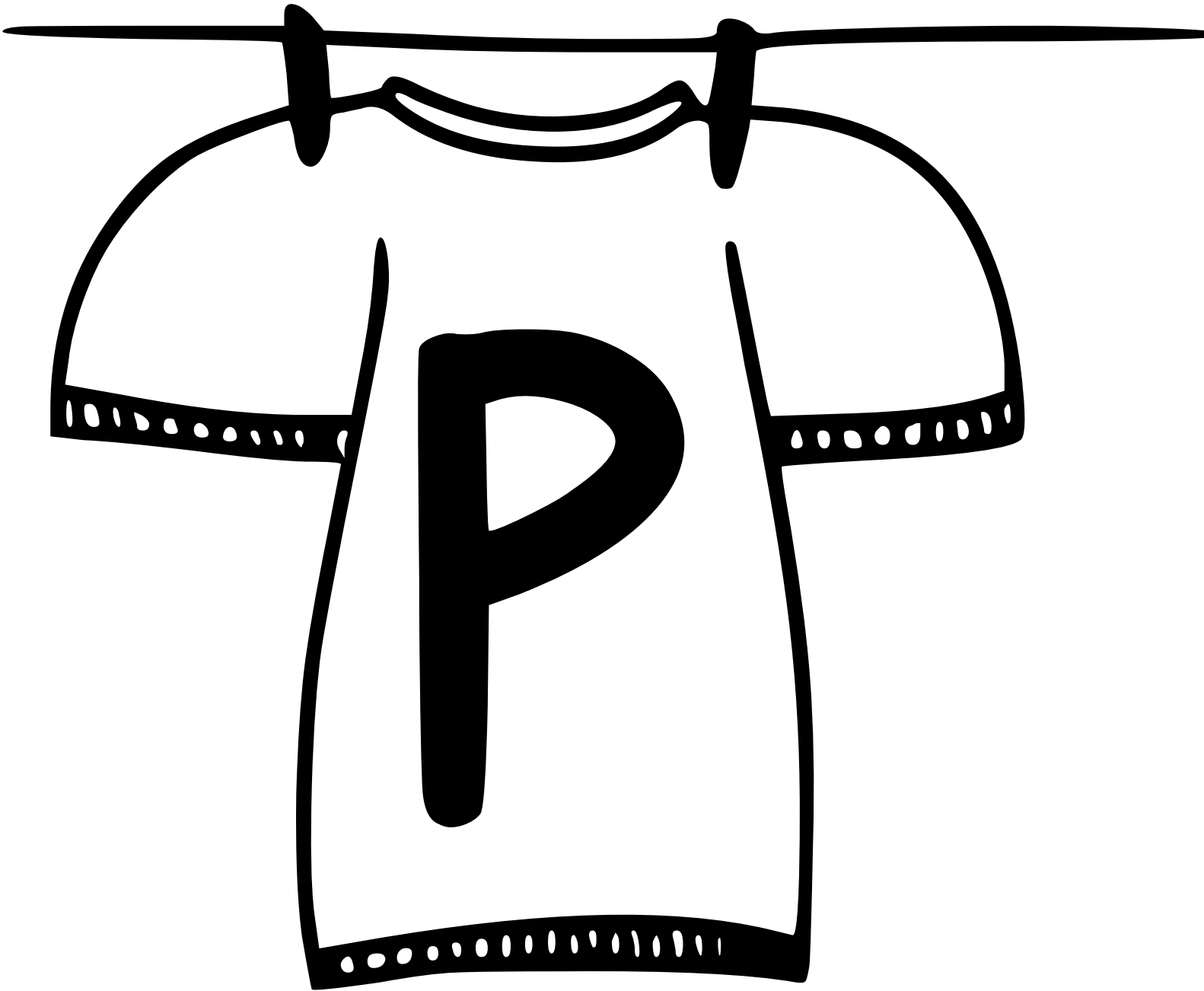

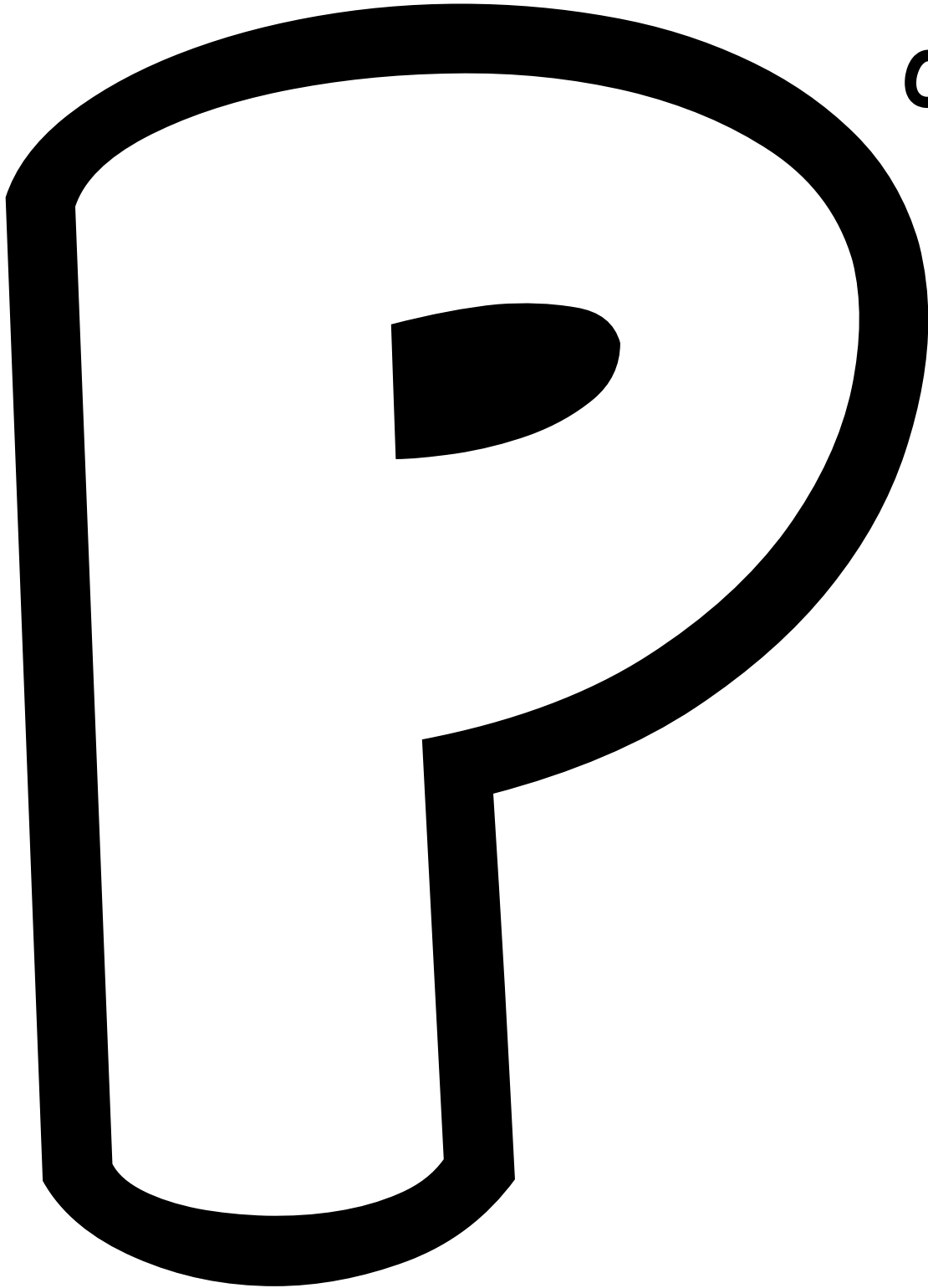

**Color to
Cover**

P is for popcorn.

Directions for Page 8:

Allow children to use crayons, stickers, tissue paper, buttons, etc. to decorate their tee.

Directions for Page 9:

Color or paint your letter "P" the color yellow.

Now use unpopped or popped corn to glue to the letter "P".